



BRAMBLE

PRODUCT TEARSHEET



# Kraton 1 Drawer Bedside Table

---

Shown in: **DRW**

SKU: **28217**

Size: **40W x 20D x 35H in**



# Overview

---

Kraton 1 Drawer Bedside Table

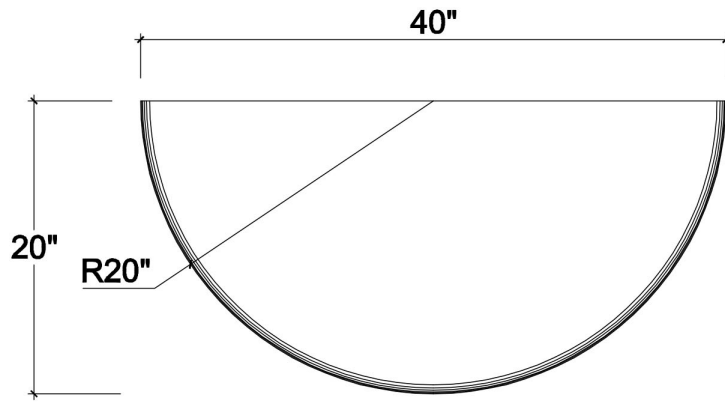

TOP VIEW

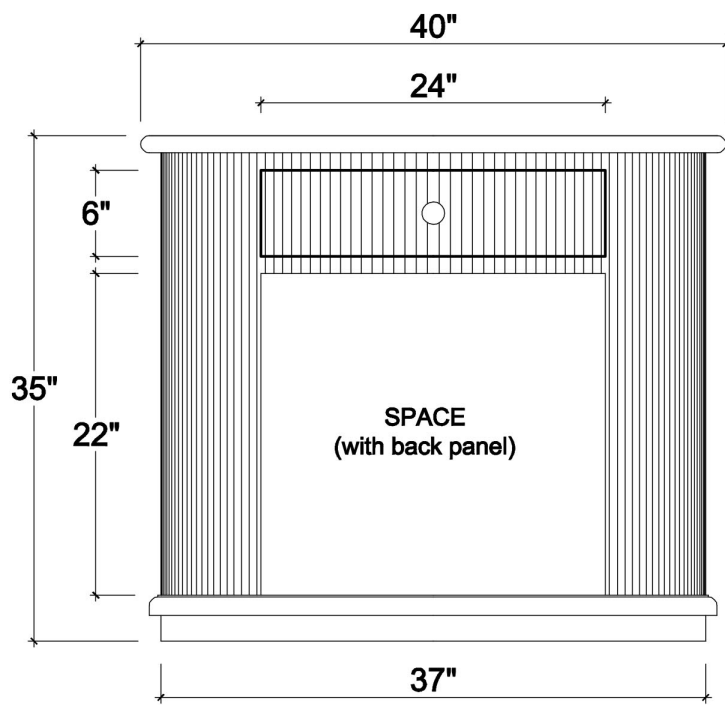

FRONT VIEW

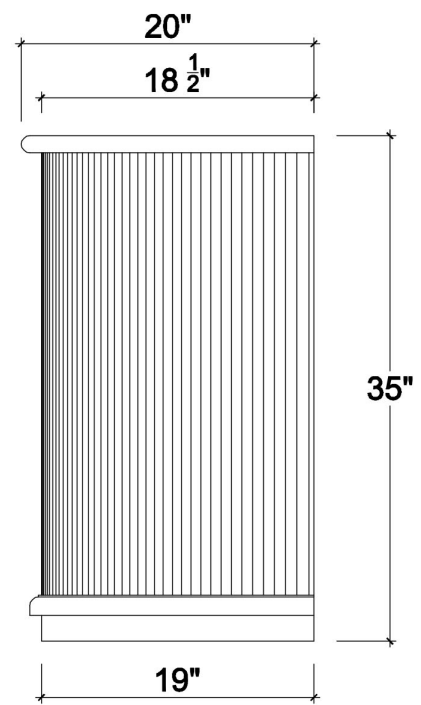

SIDE VIEW

## Visual Highlights

---

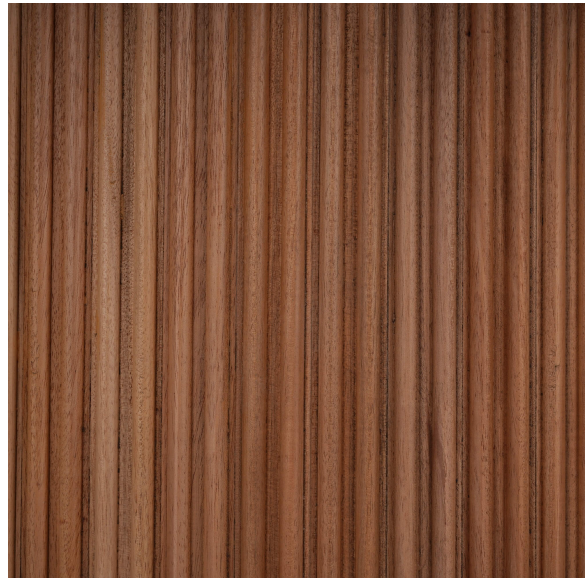



## Technical Specification

---

Dimensions	<b>40W x 20D x 35H in</b>	CBM	<b>0.55</b>
Number of Packages	<b>1</b>	Cubic Feet	<b>19.42 ft<sup>3</sup></b>
Package 1 Dimensions	<b>41.7 x 21.7 x 37.4 in</b>	Net Weight	<b>88.18 lbs</b>
Package Weight Total	<b>99.21 lbs</b>		

<https://www.brambleco.com/28217>

---