



BRAMBLE

PRODUCT TEARSHEET



Dauphine 3 Drawer Nightstand

Shown in: **WHD**

SKU: **75916**

Size: **32W x 20D x 30H in**



Overview

Dauphine 3 Drawer Nightstand

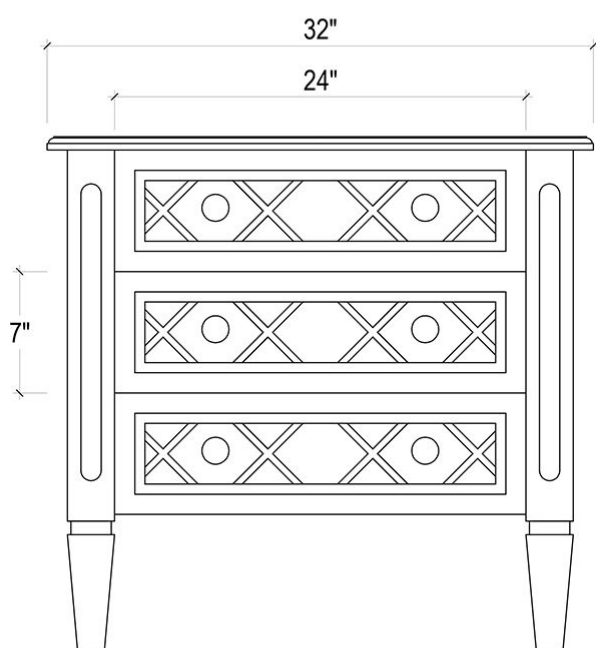

FRONT VIEW

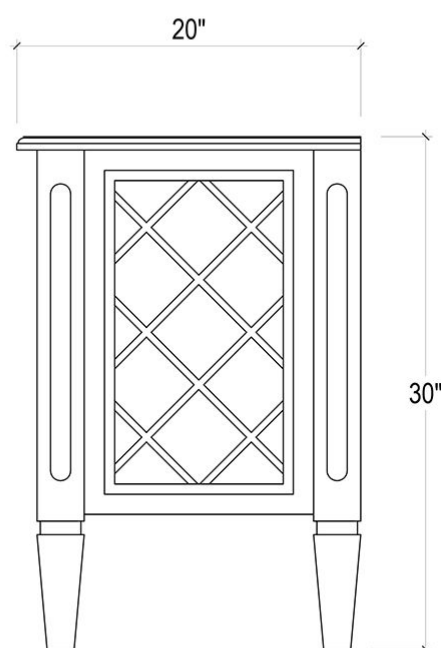

SIDE VIEW

Visual Highlights





Technical Specification

Dimensions	32W x 20D x 30H in	CBM	0.39
Number of Packages	1	Cubic Feet	13.77 ft³
Package 1 Dimensions	35 x 23.2 x 35.4 in	Package 1 Weight	72.75 lbs
Package Weight Total	72.75 lbs	Net Weight	61.73 lbs
Material	Mahogany	Best Seller	

<https://www.brambleco.com/75916>
