

EST. *B* 1991

BRAMBLE

PRODUCT TEARSHEET



Dauphine Nightstand Small

Shown in: **WHD**

SKU: **75915**

Size: **24W x 20D x 30H in**



Overview

Dauphine Nightstand Small

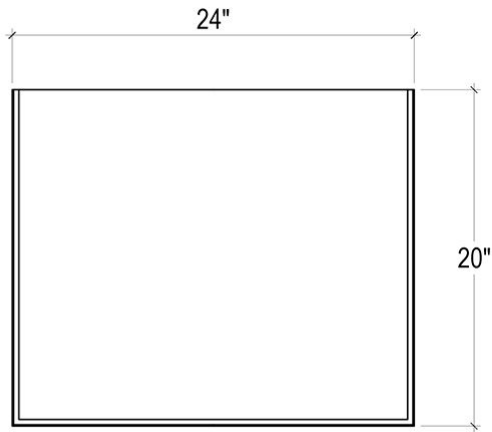

TOP VIEW

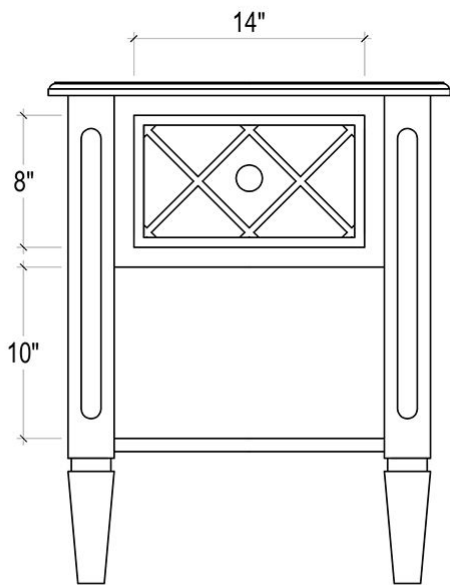

FRONT VIEW

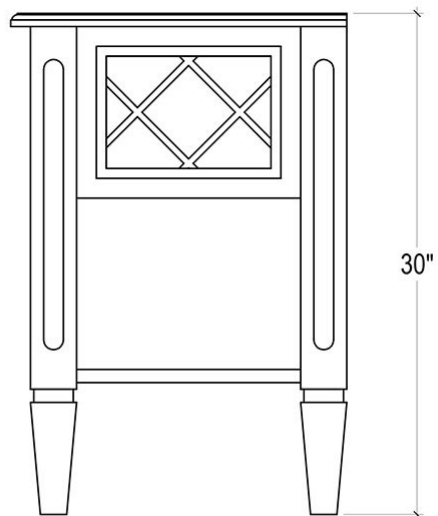

SIDE VIEW

Visual Highlights



Technical Specification

Dimensions	24W x 20D x 30H in	CBM	0.3
Number of Packages	1	Cubic Feet	10.59 ft³
Package 1 Dimensions	25.6 x 21.7 x 32.7 in	Package 1 Weight	55.12 lbs
Package Weight Total	55.12 lbs	Net Weight	48.5 lbs
Material	Mahogany		

<https://www.brambleco.com/75915>
